

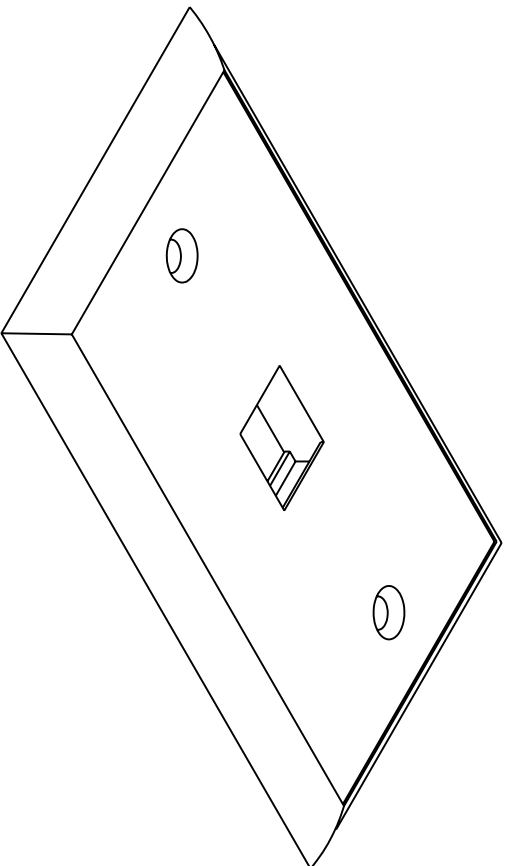

REVISIONS				
ZONE	REV	DESCRIPTION	DATE	APPROVED

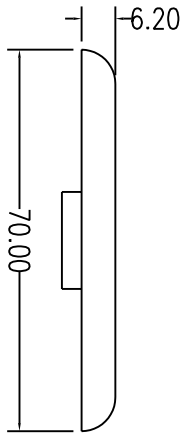
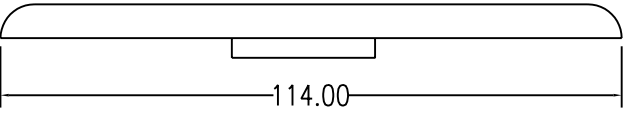
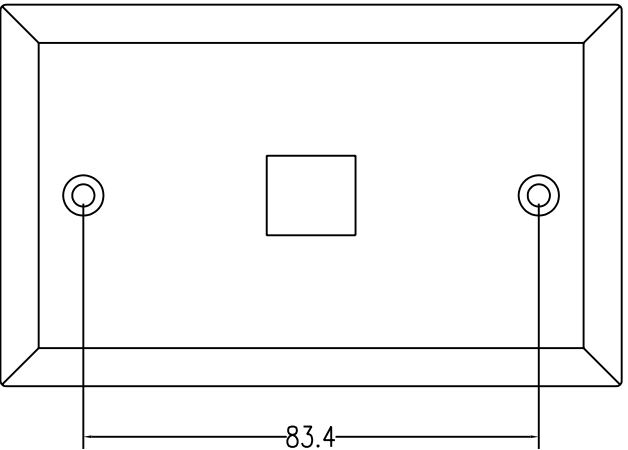

MATERIALS: ABS UL94V-0
COLOR: WHITE, IVORY.....
ENCLOSURE: K4 6 x 25mm SCREW X 2 

COMMON TOLERANCE		SHEET 1 OF 1		ALL COPY RIGHTS RESERVED	
CLASS	A	B	SIZE	A4	 DAN-CHIEF ENTERPRISE CO.,LTD.
DIMENSION	±0.05	±0.1	DIA	mm	
L<=3	±0.05	±0.1	SCALE	2:3	3020AP-1-XX-X
3<L<=6	±0.05	±0.1	DATE	APR.21.2001	DRAWING NO. B-072-1
6<L<=16	±0.1	±0.15	DESIGN		DRAWN
16<L<=30	±0.1	±0.2	CHECKED		
30<L<=120	±0.15	±0.3			
120<L<=315	±0.2	±0.5			

REVISIONS				
ZONE	REV	DESCRIPTION	DATE	APPROVED

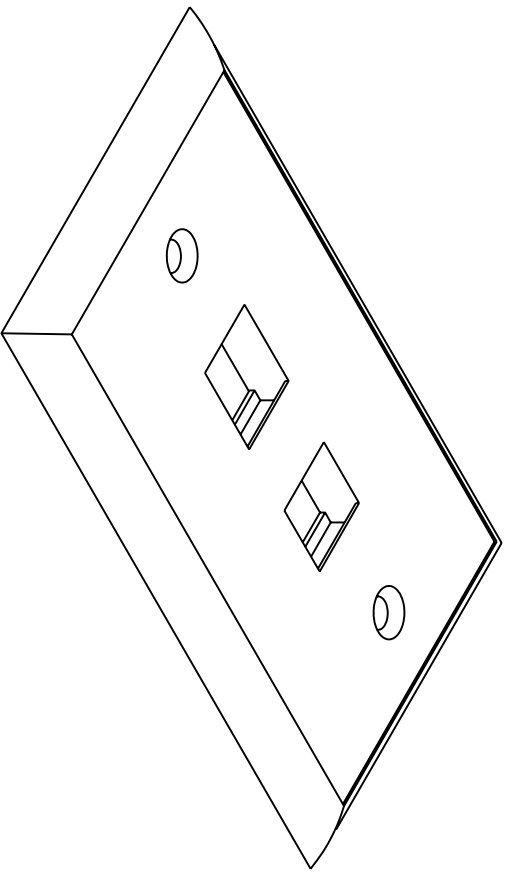
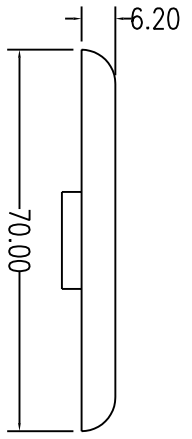
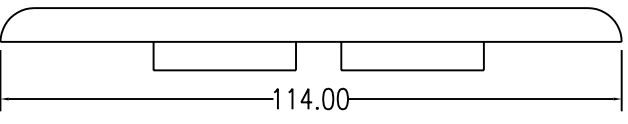
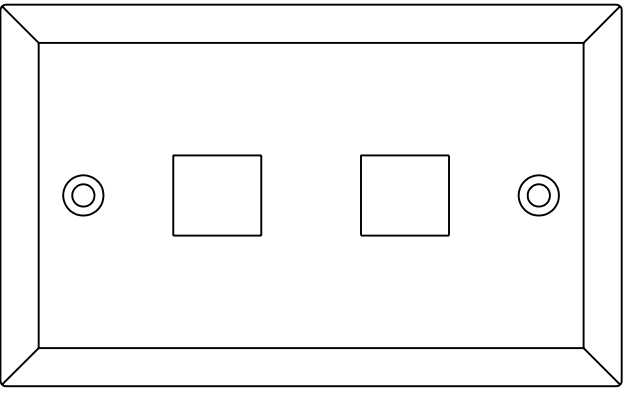

MATERIALS: ABS UL94V-0
COLOR: WHITE, IVORY.....
ENCLOSURE: K4 6 x 25mm SCREW X 2 

COMMON TOLERANCE		SHEET 1 OF 1		ALL COPY RIGHTS RESERVED	
CLASS	A	B	SIZE	A4	DCE DAN-CHIEF ENTERPRISE CO.,LTD.
DIMENSION	±0.05	±0.1	DIA	mm	TITLE
L<=3	±0.05	±0.1	SCALE	2:3	3020AP-2-XX-X
3<L<=6	±0.05	±0.1	DATE	APR.21.2001	DRAWING NO.
6<L<=16	±0.1	±0.15	DESIGN		B-072-2
16<L<=30	±0.1	±0.2	DRAWN		CHECKED
30<L<=120	±0.15	±0.3			
120<L<=315	±0.2	±0.5			

REVISIONS			
ZONE	REV	DESCRIPTION	DATE APPROVED

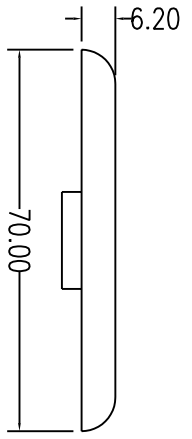
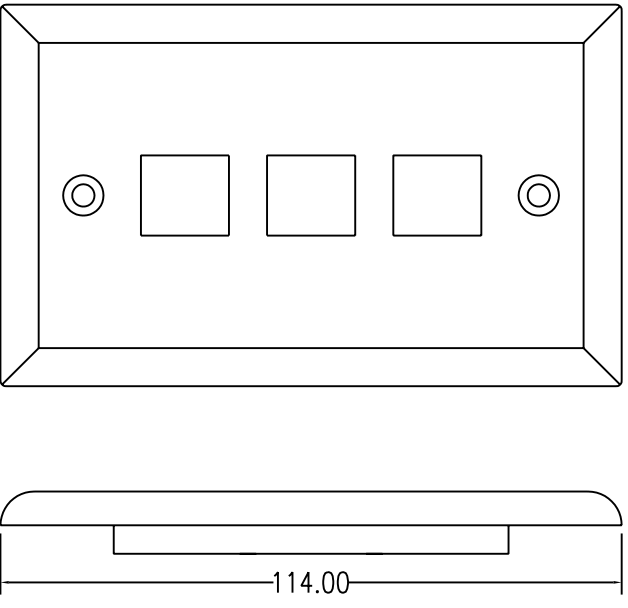

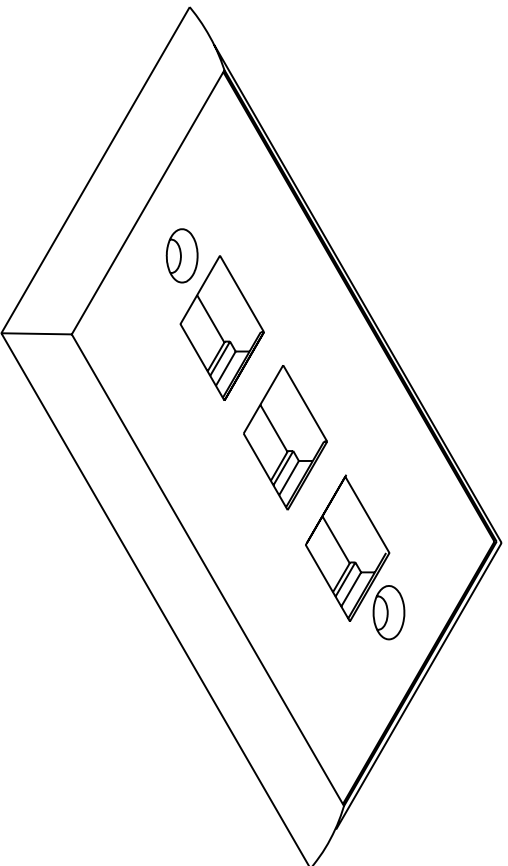

MATERIALS: ABS UL94V-0
 COLOR: WHITE, IVORY.....
 ENCLOSURE:
 K4 6 x 25mm SCREW X 2 

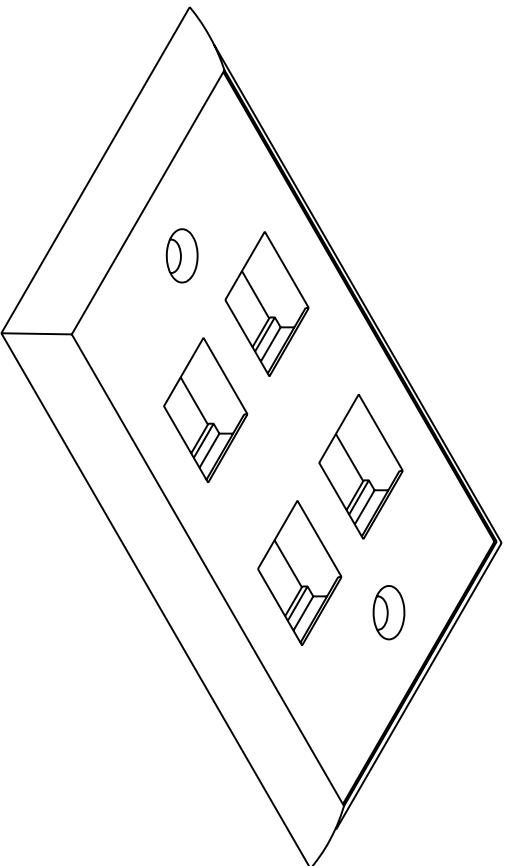
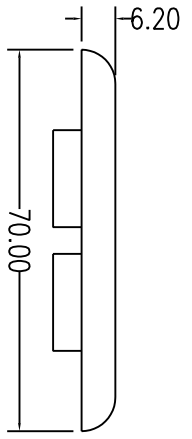
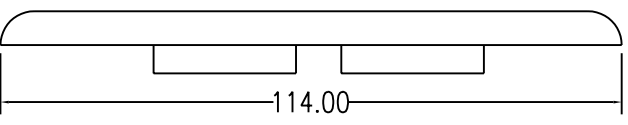
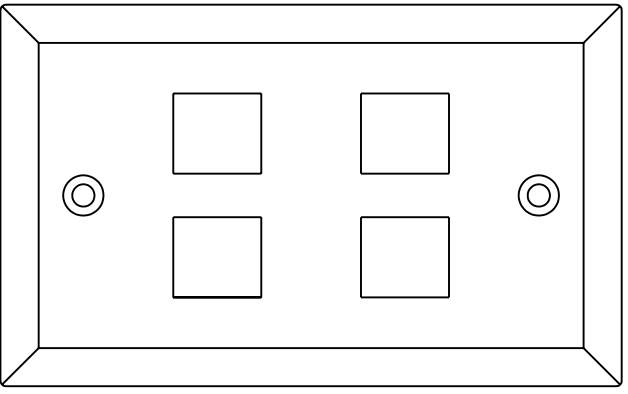

COMMON TOLERANCE		SHEET 1 OF 1		ALL COPY RIGHTS RESERVED	
CLASS	A	B	SIZE	A4	TITLE
DIMENSION	±0.05	±0.1	DIA	mm	 DAN-CHIEF ENTERPRISE CO.,LTD. 3020AP-3-XX-X
L<=3	±0.05	±0.1	SCALE	2:3	
3<L<=6	±0.05	±0.1	DATE	APR.21.2001	
6<L<=16	±0.1	±0.15	DESIGN		
16<L<=30	±0.1	±0.2	DRAWING NO.	B-072-3	
30<L<=120	±0.15	±0.3	DRAWN		CHECKED
120<L<=315	±0.2	±0.5			

REVISIONS			
ZONE	REV	DESCRIPTION	DATE APPROVED



MATERIALS: ABS UL94V-0
COLOR: WHITE, IVORY.....
ENCLOSURE: K4 6 x 25mm SCREW X 2 

COMMON TOLERANCE			SHEET 1 OF 1		ALL COPY RIGHTS RESERVED	
CLASS	A	B	SIZE	A4	DCE DAN-CHIEF ENTERPRISE CO.,LTD.	
DIMENSION	±0.05	±0.1	DIA	mm	TITLE	
L<=3	±0.05	±0.1	SCALE	2:3	3020AP-4-XX-X	
3<L<=6	±0.05	±0.1	DATE	APR.21.2001	DRAWING NO. B-072-4	
6<L<=16	±0.1	±0.15	DESIGN		DRAWN	
16<L<=30	±0.1	±0.2			CHECKED	
30<L<=120	±0.15	±0.3				
120<L<=315	±0.2	±0.5				

REVISIONS			
ZONE/REV	DESCRIPTION	DATE	APPROVED

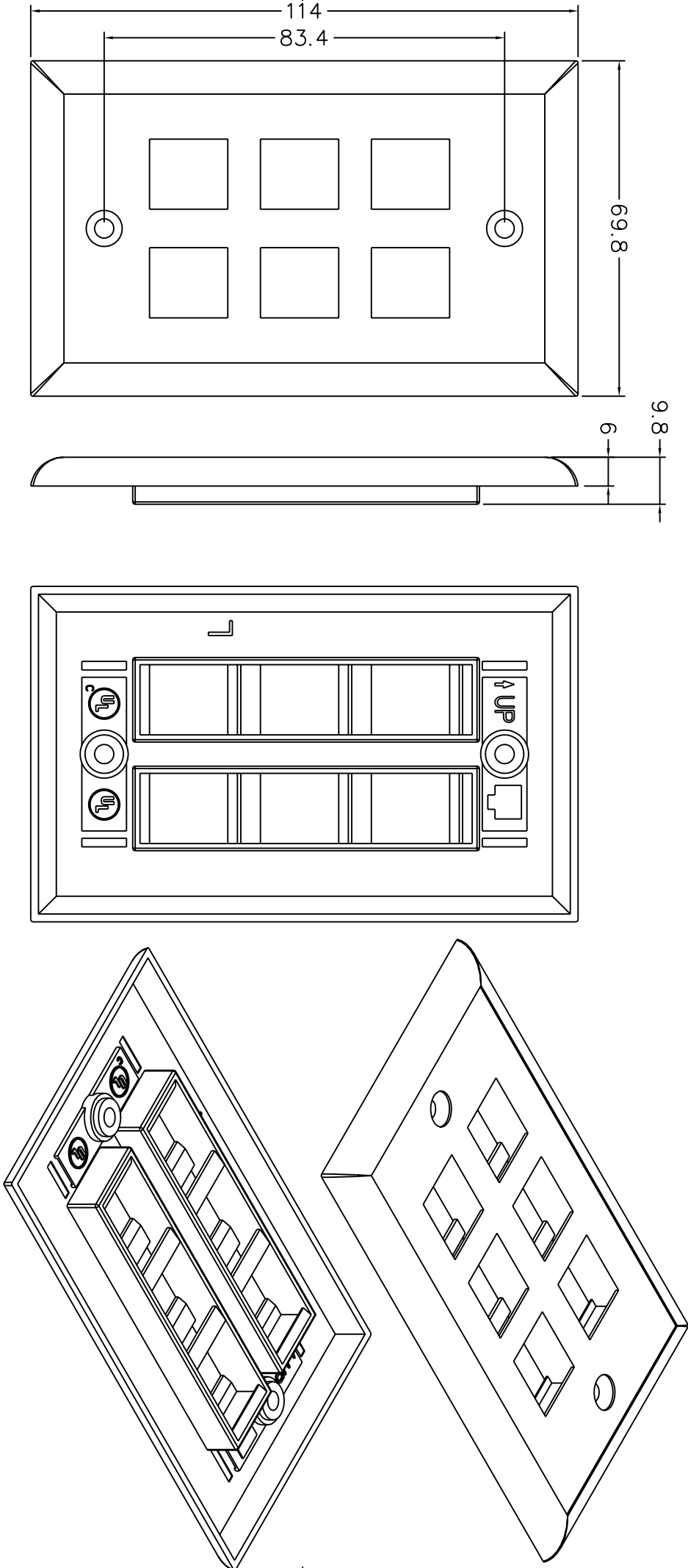

MATERIALS: ABS UL94V-0

ENCLOSURE PARTS:

 K4 6x25mm SCREW X 2

COMMON TOLERANCE		SHEET 1 OF 1		ALL COPY RIGHTS RESERVED	
CLASS	A	B	SIZE	A4	 DAN-CHIEF ENTERPRISE CO.,LTD.
DIMENSION	L <= 3 ±0.07 ±0.1		UNIT:	mm	TITLE
	3 < L <= 6 ±0.05 ±0.1		SCALE:		3020AP-6-XX-X
	6 < L <= 16 ±0.1 ±0.15		DATE:	2001.12.1	DRAWING NO.
	16 < L <= 30 ±0.1 ±0.2		DESIGN		B-072-6
	30 < L <= 120 ±0.15 ±0.3		DRAWN		CHECKED
	120 < L <= 315 ±0.2 ±0.5				