

CAP

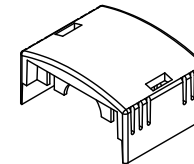

Cat 6
UL CERTIFIED

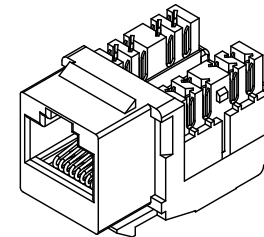
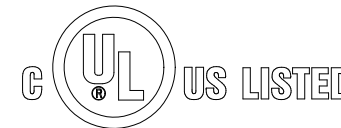

ACCORDING TO TIA/EIA-568-B.2-1
REQUIREMENTS
FILE NO.E145249

MATERIAL

Housing:ABS UL94V-0
IDC plastic:PC UL94V-0
IDC contact:Phosphor Bronze with 200u" Tin over 100u" Nickel undercoat
Spring Wire:Phosphor Bronze with 50u" Gold over 100u" Nickel undercoat
Operating Temperature:-40 °C~-68 °C
Humidity:10%~90%RH
Modular jack:750 mating cycles
IDC block:200 termination cycles

ELECTRICAL

Current rating:1.5Amps
Insulation resistance:500MOhm
Contact resistance:20mOhm
DC resistance:0.1ohm
Dielectric withstanding voltage:1000V

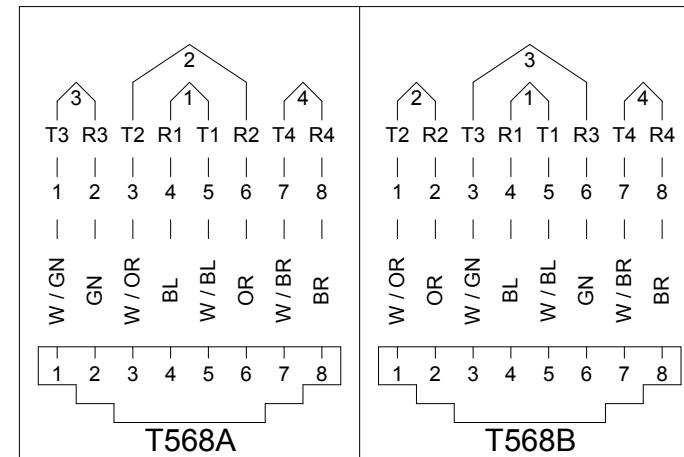

TOLERANCE				
~20	~50	~150	150~	ANGLE
±0.20	±0.40	±0.50	±1.50	±2°

Scale	1:1	ALL COPY RIGHTS RESERVED	
3rd Angle Projection			
Unit	mm	Title	
Material		3013A-EK8-C6L-XX	
Color		Drawn by	Checked by
Date	2005/10/28	ALLEN LI	

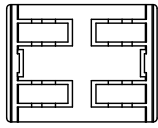
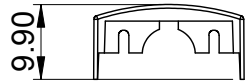
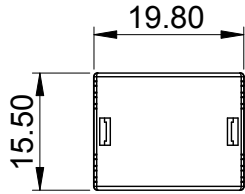

CAP

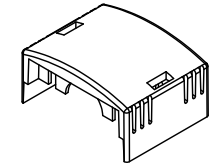
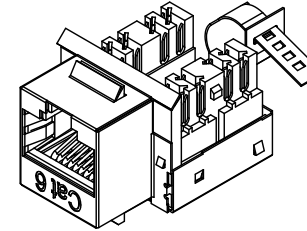
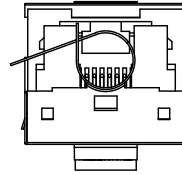
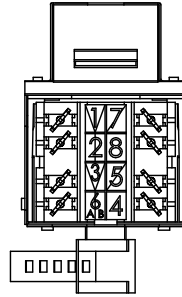
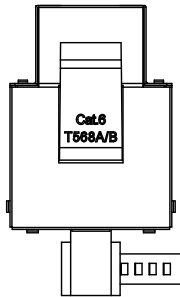
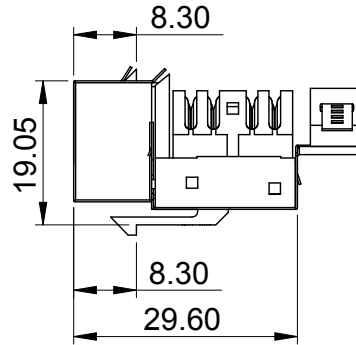
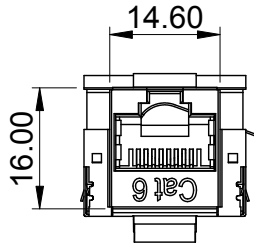

Cat 6
UL CERTIFIED

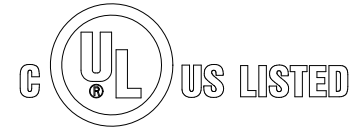

ACCORDING TO TIA/EIA-568-B.2-1
REQUIREMENTS
FILE NO.E145249

MATERIAL

Housing:ABS UL94V-0
IDC plastic:PC UL94V-0
IDC contact:Phosper Bronze with 200u" Tin over 100u" Nickel undercoat
Spring Wire:Phosper Bronze with 50u" Gold over 100u" Nickel undercoat
Operating Temperature:-40 °C~-68 °C
Humidity:10%~90%RH
Modular jack:750 mating cycles
IDC block:200 termination cycles
Shiled:Bronze with Nickel plated

ELECTRICAL

Current rating:1.5Amps
Insulation resistance:500MOhm
Contact resistance:20mOhm
DC resistance:0.1ohm
Dielectric withstanding voltage:1000V

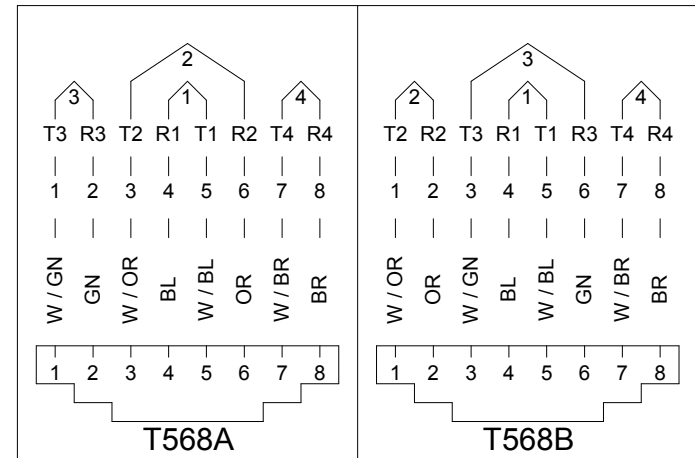

TOLERANCE				
~20	~50	~150	150~	ANGLE
±0.20	±0.40	±0.50	±1.50	±2°

Scale	1:1	ALL COPY RIGHTS RESERVED	
3rd Angle Projection		DAN-CHEF ENTERPRISE CO.,LTD.	
Unit	mm	Title	
Material		3013A-EK8HS-C6L-XX	
Color		Drawn by	Checked by
Date	2005/10/28	ALLEN LI	

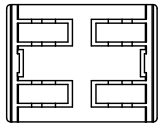
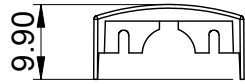
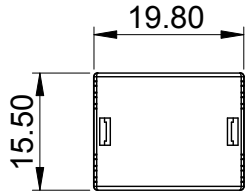

CAP

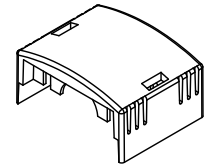
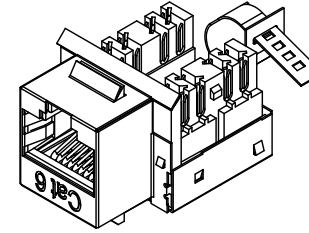
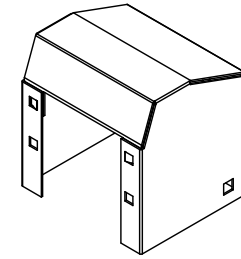
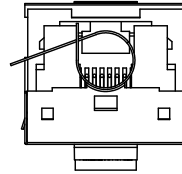
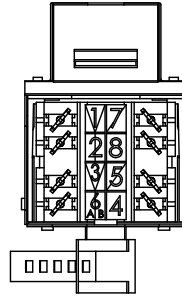
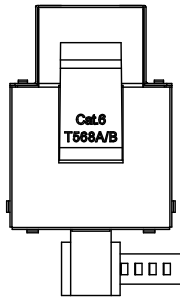
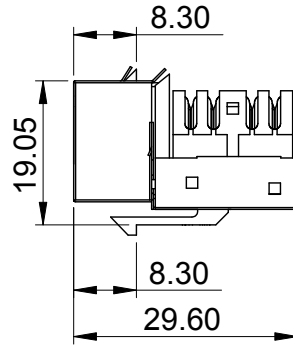
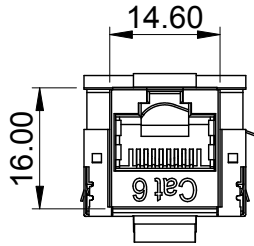

MATERIAL

Housing:ABS UL94V-0
 IDC plastic:PC UL94V-0
 IDC contact:Phospher Bronze with 200u" Tin over 100u" Nickel undercoat
 Spring Wire:Phospher Bronze with 50u" Gold over 100u" Nickel undercoat
 Operating Temperature:-40 °C~-68 °C
 Humidity:10%~90%RH
 Modular jack:750 mating cycles
 IDC block:200 termination cycles
 Shiled:Bronze with Nickel plated

Cat 6
 UL CERTIFIED

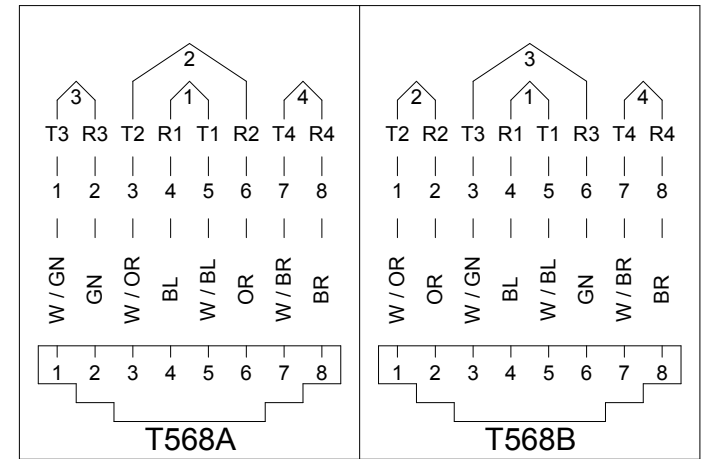
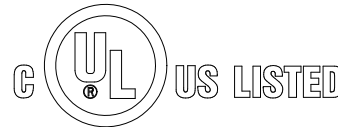

ELECTRICAL

Current rating:1.5Amps
 Insulation resistance:500MOhm
 Contact resistance:20mOhm
 DC resistance:0.1ohm
 Dielectric withstanding voltage:1000V

ACCORDING TO TIA/EIA-568-B.2-1
 REQUIREMENTS
 FILE NO.E145249

TOLERANCE				
~20	~50	~150	150~	ANGLE
±0.20	±0.40	±0.50	±1.50	±2°

Scale	1:1	ALL COPY RIGHTS RESERVED	
3rd Angle Projection		DAN-CHIEF ENTERPRISE CO.,LTD.	
Unit	mm	Title	
Material		3013A-EK8S-C6L-XX	
Color		Drawn by	Checked by
Date	2005/10/28	ALLEN LI	