

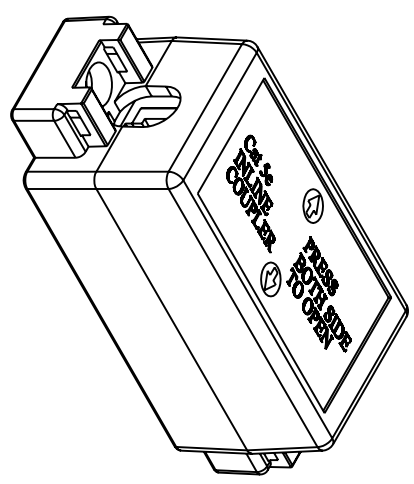

REVISIONS				
ZONE	REV	DESCRIPTION	DATE	APPROVED
	1			
	2			
	3			
	4			

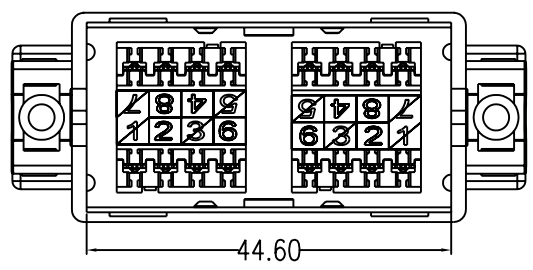

Cat 5e
UL CERTIFIED

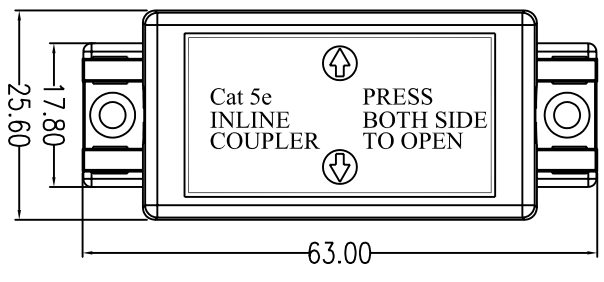

US LISTED

ACCORDING TO TIA/EIA-568-B-2
REQUIREMENTS
FILE NO. E145249

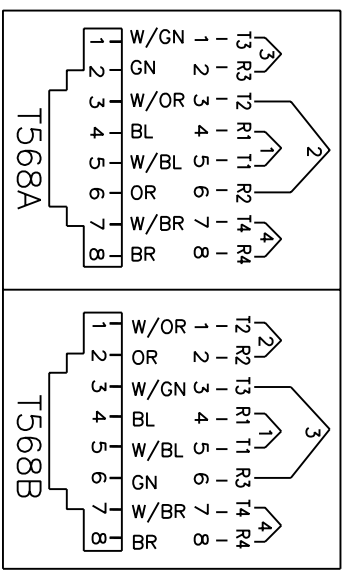
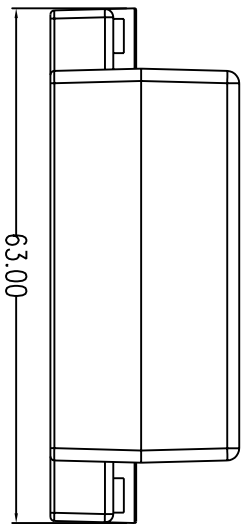
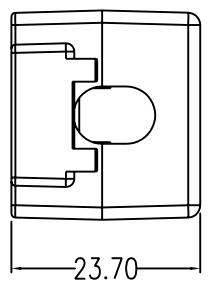

MATERIAL

Housing: ABS, UL 94V-0
IDC plastic: PC, UL 94V-0
IDC contact: Phosphor Bronze with 200u
" Tin over 100u" Nickel undercoat
Spring Wire: Phosphor Bronze with 50u
" Gold over 100u" Nickel undercoat
Temperature: -40°C ~ 70°C
Humidity: 10% ~ 90% RH
Idc block: 200 termination cycles

ELECTRICAL

Current rating: 1.5 Amps
Insulation resistance: 500 MOhm
Contact resistance: 20 mOhm
DC resistanc: 0.1 Ohm
Dielectric withstanding voltage: 1000 V

COMMON TOLERANCE		SHEET OF		ALL COPY RIGHTS RESERVED	
CLASS	A	B	SIZE	A4	DCE DAN-CHIEF ENTERPRISE CO., LTD.
DIMENSION	±0.05	±0.1	DIA	mm	TITLE
L <= 3	±0.05	±0.1	SCALE	1:1	2100D-VH8-C5eL-XX
3 < L <= 6	±0.05	±0.1	DATE	2004.05.06	DRAWING NO. C-033
6 < L <= 16	±0.1	±0.15	DESIGN		CHECKED
16 < L <= 30	±0.1	±0.2			
30 < L <= 120	±0.15	±0.3			
120 < L <= 315	±0.2	±0.5			