

REVISIONS				
ZONE	REV	DESCRIPTION	DATE	APPROVED
	1			
	2			
	3			
	4			

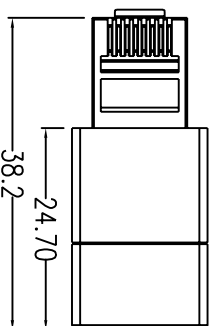
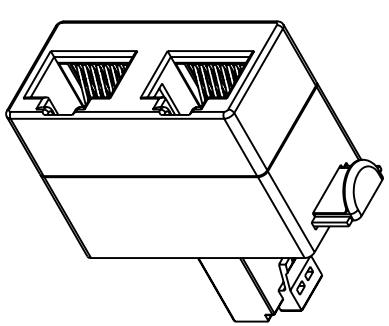
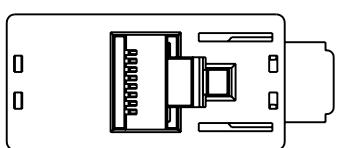
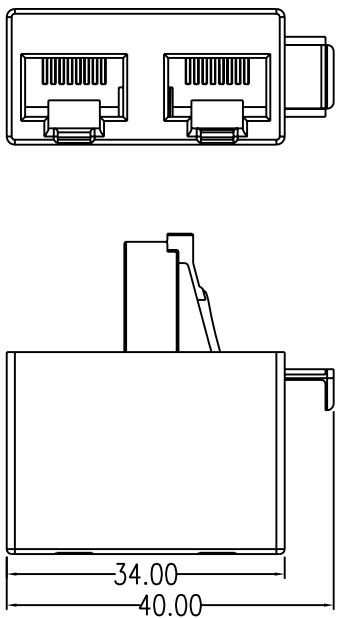
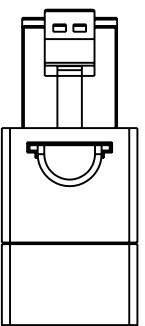
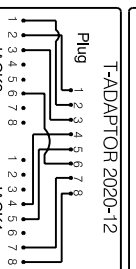
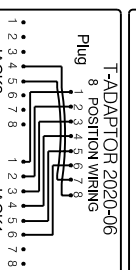
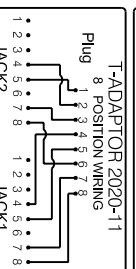
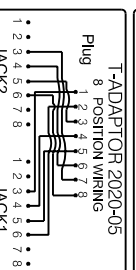
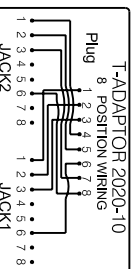
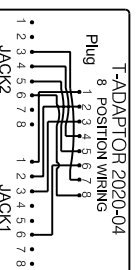
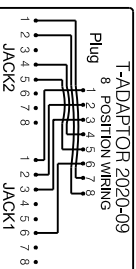
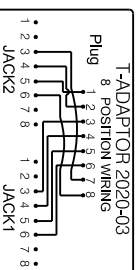
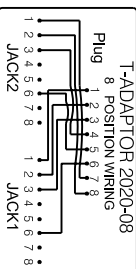
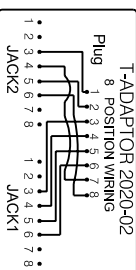
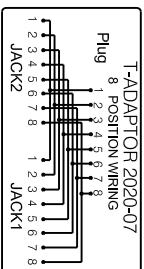
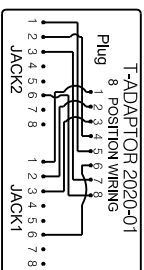

MATERIAL

Housing: ABS, UL 94V-0

Spring Wire: Phosphor Bronze with 50u

" Gold over 100u" Nickel undercoat

Temperature: -40°C ~ 68°C

Humidity: 10% ~ 90% RH

Modular Jack: 750 mating cycles

Modular Plug Housing: Poly-carbonate UL94V-2

Modular Plug Contact: 6U" GOLD-PLATED

ELECTRICAL

Current rating: 1.5 Amps

Insulation resistance: 500 MOhm

Contact resistance: 20 mOhm

DC resistance: 0.1 Ohm

Dielectric withstanding voltage: 1000 V

COMMON TOLERANCE		SHEET	OF	ALL COPY RIGHTS RESERVED	
CLASS	A	SIZE	A4	DCE DAN-CHIEF ENTERPRISE CO., LTD.	
DIMENSION		DIA	mm	TITLE	
L <= 3	±0.05			2020 SERIES	
3 < L <= 6	±0.05	SCALE	1:1	DRAWING NO.	C-069
6 < L <= 16	±0.1	DATE	2004.09.29	DRAWN	CHECKED
16 < L <= 30	±0.1	DESIGN			
30 < L <= 120	±0.15				
120 < L <= 315	±0.2				