

REVISIONS				
ZONE	REV	DESCRIPTION	DATE	APPROVED
	1			
	A			

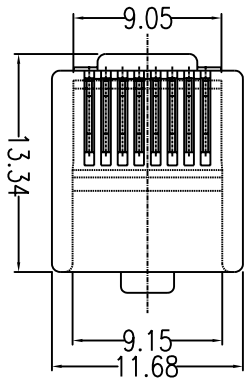
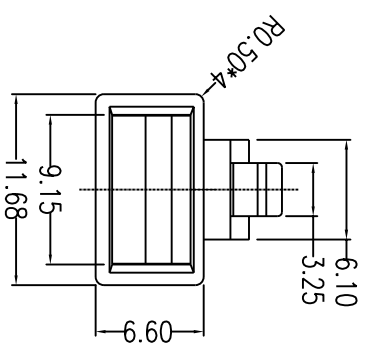
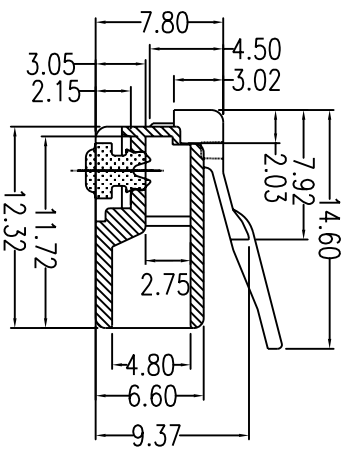
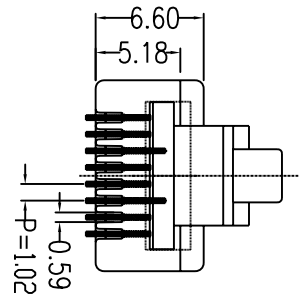
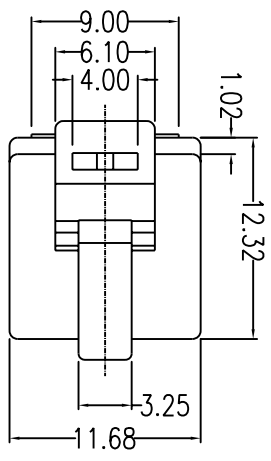

NOTE TOL: ±0.1

**SPECIFICATION MECHANICAL:**

1. Housing Material: Polycarbonate, UL 94V0.
2. Material Contact: Phosphor Bronze.
3. Housing Color: Transparency.
4. Operation Temperature: -40°C to 80°C.

COMMON TOLERANCE		SHEET	OF	ALL COPY RIGHTS RESERVED	
CLASS	A	SIZE	A4	DCE DAN-CHIEF ENTERPRISE CO., LTD.	
DIMENSION		DIA	mm	TITLE	
L <= 3	±0.05			101S-88-50U-C6	
3 < L <= 6	±0.05			DRAWING NO. G-004	
6 < L <= 16	±0.1			DATE 2004.03.08	
16 < L <= 30	±0.1			DESIGN	
30 < L <= 120	±0.15			DRAWN	
120 < L <= 315	±0.2			CHECKED	

REVISIONS				
ZONE	REV	DESCRIPTION	DATE	APPROVED
	1			
	2			
	3			

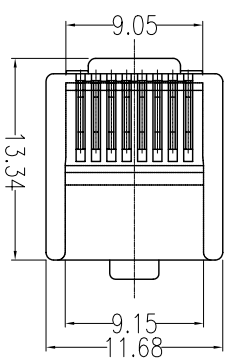
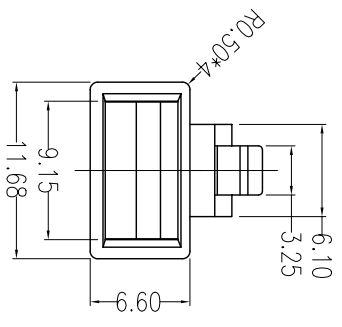
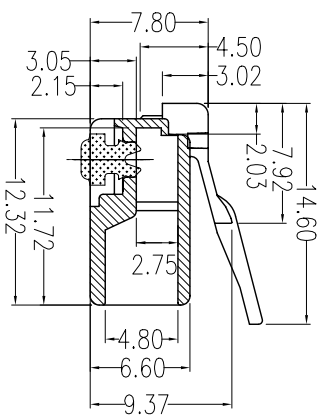
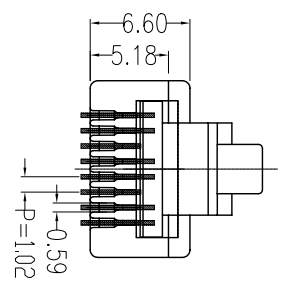
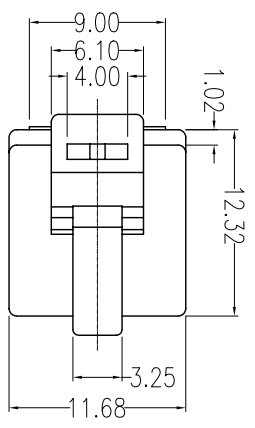

NOTE TOL: ±0.1

**SPECIFICATION  
MECHANICAL:**

- 1.Housing Material:Polycarbonate, UL 94V0.
- 2.Material Contact:Phosphor Bronze.
- 3.Housing Color:Transparence.
- 4.Operation Temperature:-40°C to 80°C.

COMMON TOLERANCE		SHEET OF		ALL COPY RIGHTS RESERVED	
CLASS	A	B	SIZE	A4	 <b>DAN-CHIEF ENTERPRISE CO.,LTD.</b> TITLE <b>101S-88-50U-BL-C6</b> DRAWING NO. <b>G-005-1</b>
DIMENSION	L<=3	±0.05	DIA	mm	
	3<L<=6	±0.05	SCALE	2:1	
	6<L<=16	±0.1	DATE	2004.03.08	
	16<L<=30	±0.1	DESIGN		
	30<L<=120	±0.15	DRAWN		CHECKED
	120<L<=315	±0.2			